

# LT3004WH-A-Q&LT3004WH-A-GL

## Package Dimension 封装尺寸

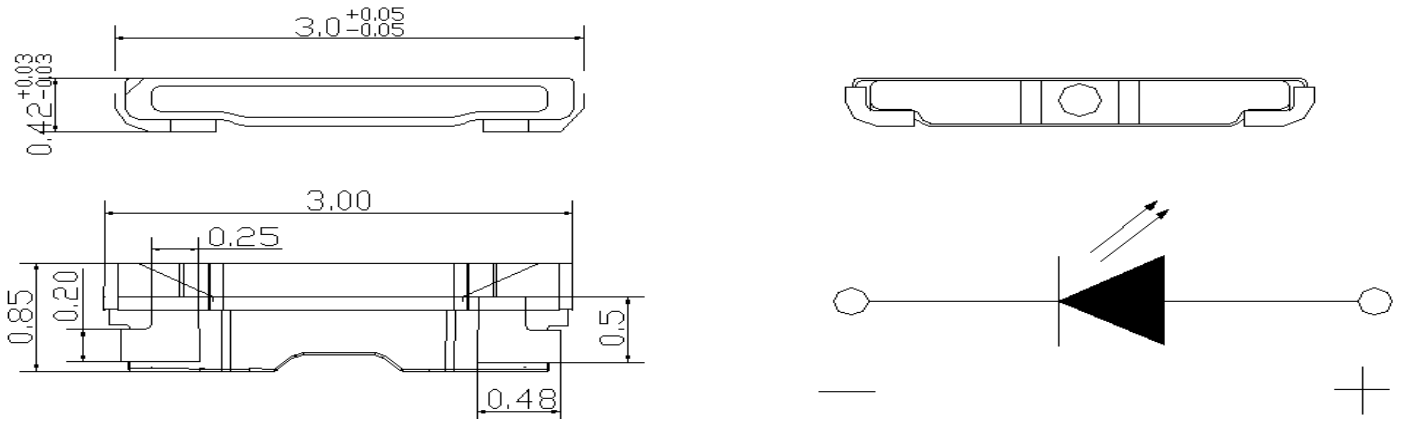

### Notes 备注:

1. All dimensions units are millimeters. 所有尺寸标注单位为毫米
2. All dimensions tolerances are  $\pm 0.1$ mm unless otherwise noted.除特别标注外, 所有尺寸公差为 $\pm 0.1$  毫米